



TRAINING PLANNING

Nephos (νέφος) = Cloud, 6 = IPv6

IT Transformation Context – Three Major Inflexion Points



Driver

Business Results

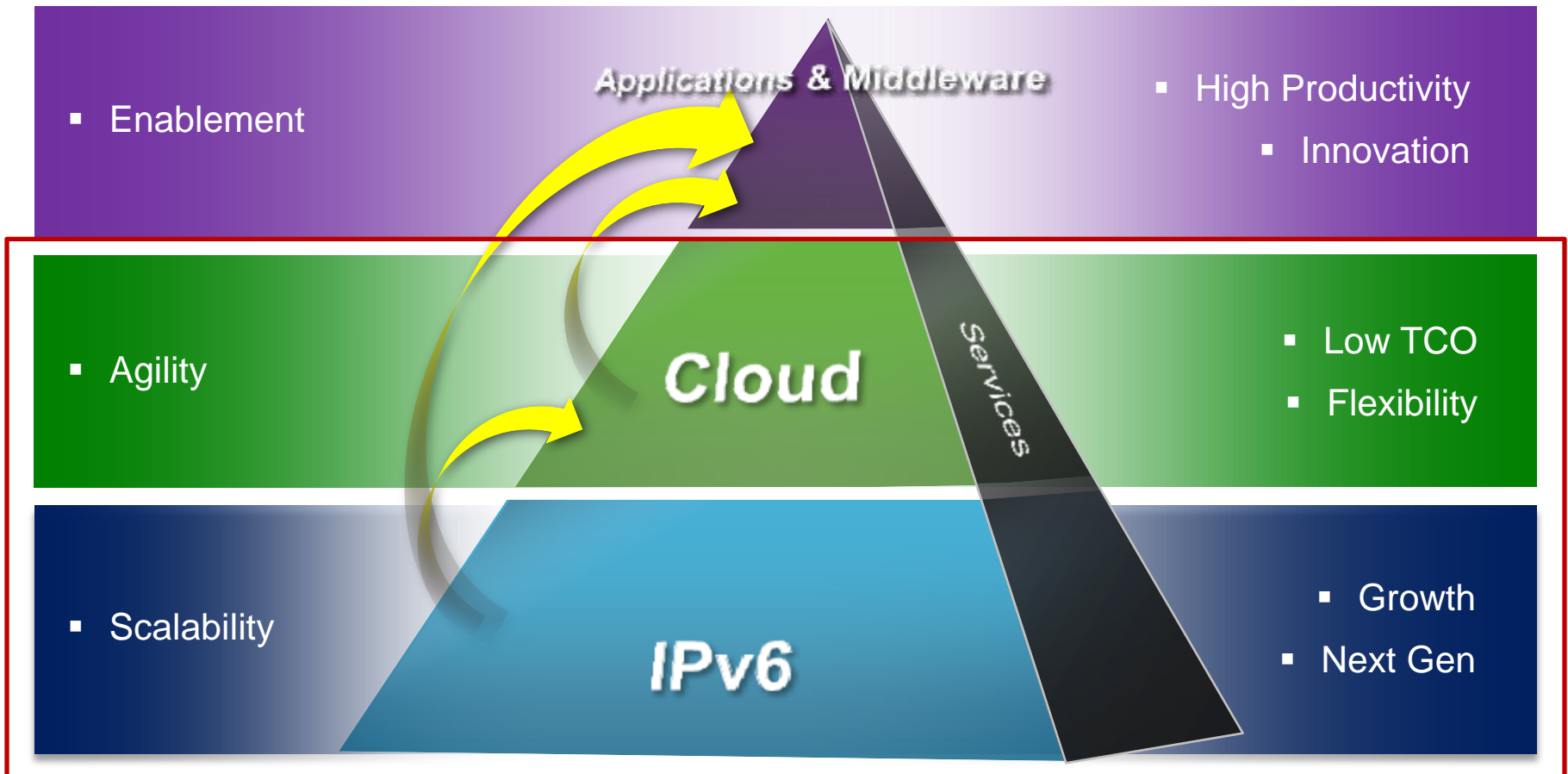

It is no longer about should I move to IPv6, it is more about how do we do it

Business Problem – The Right Perspective



- 78% of IT leaders said made/making the transition to IPv6
- 94% of work began within the past two years
- 55% have sought/plan to seek assistance of consultants
- 54% deemed the move essential to the organization
- 73% were concerned about missing out on the benefits
- 92% indicate that security team is involved in transition efforts
- 56% believe responsibility should fall on SP and the company
- 63% indicate an executive committee is overseeing the effort

Cisco Survey: <http://www.networkworld.com/news/2011/052411-cisco-ipv6.html>

Five Steps to IPv6 – What to Train For

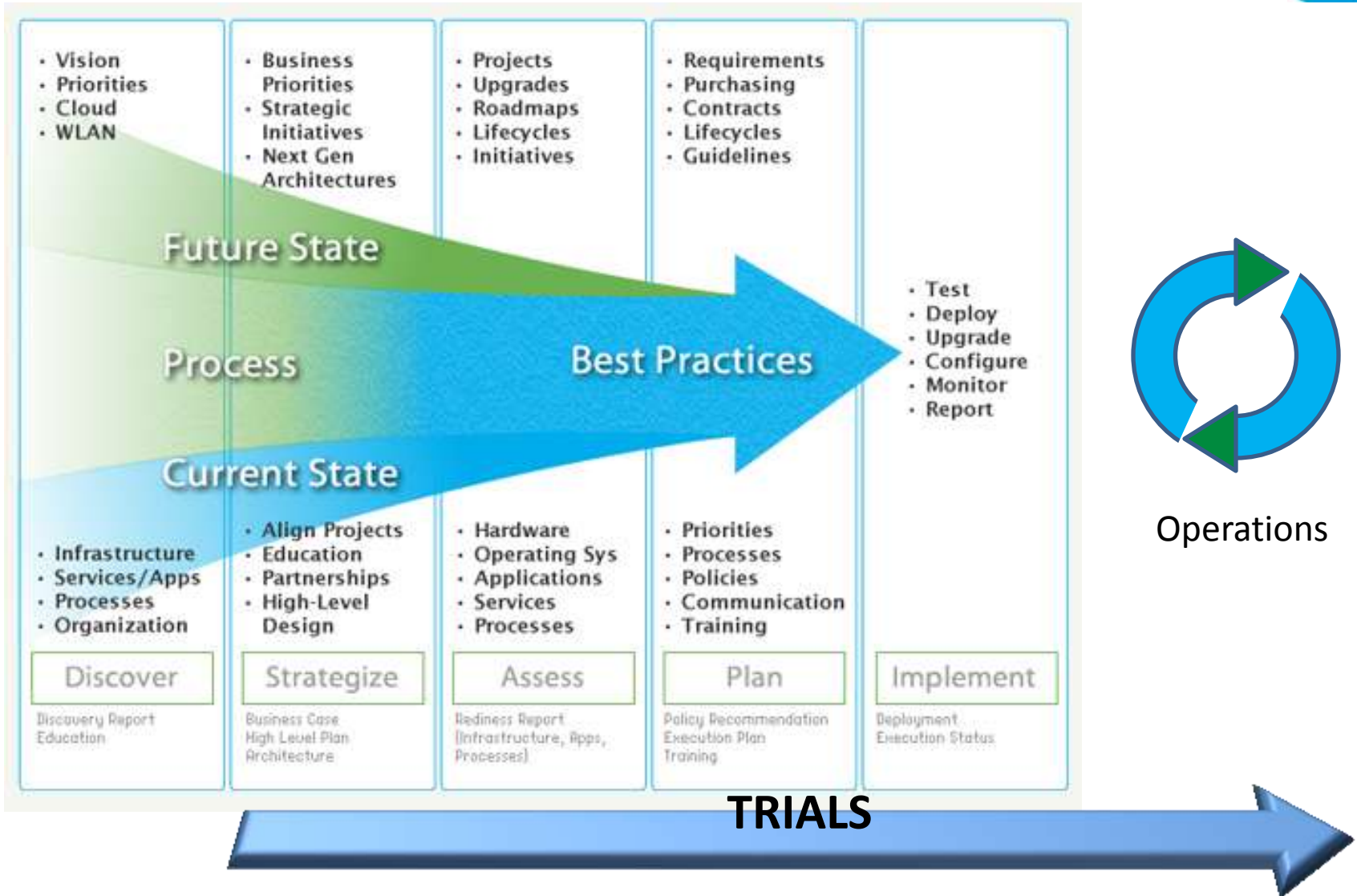

Touching All Aspects of IT – Who to Train (Infrastructure)

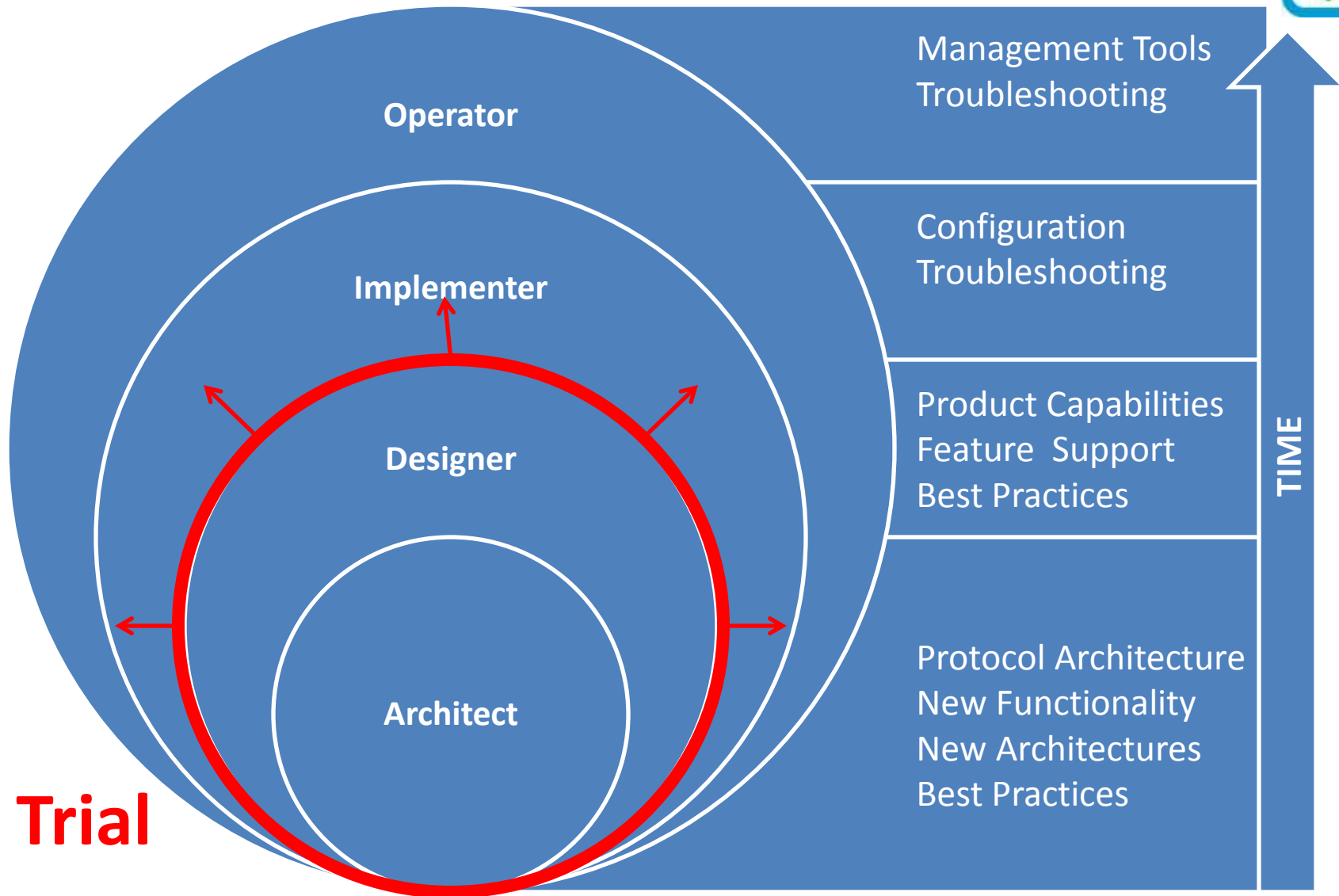

Trial



Touching All Aspects of IT – Who to Train (Applications)

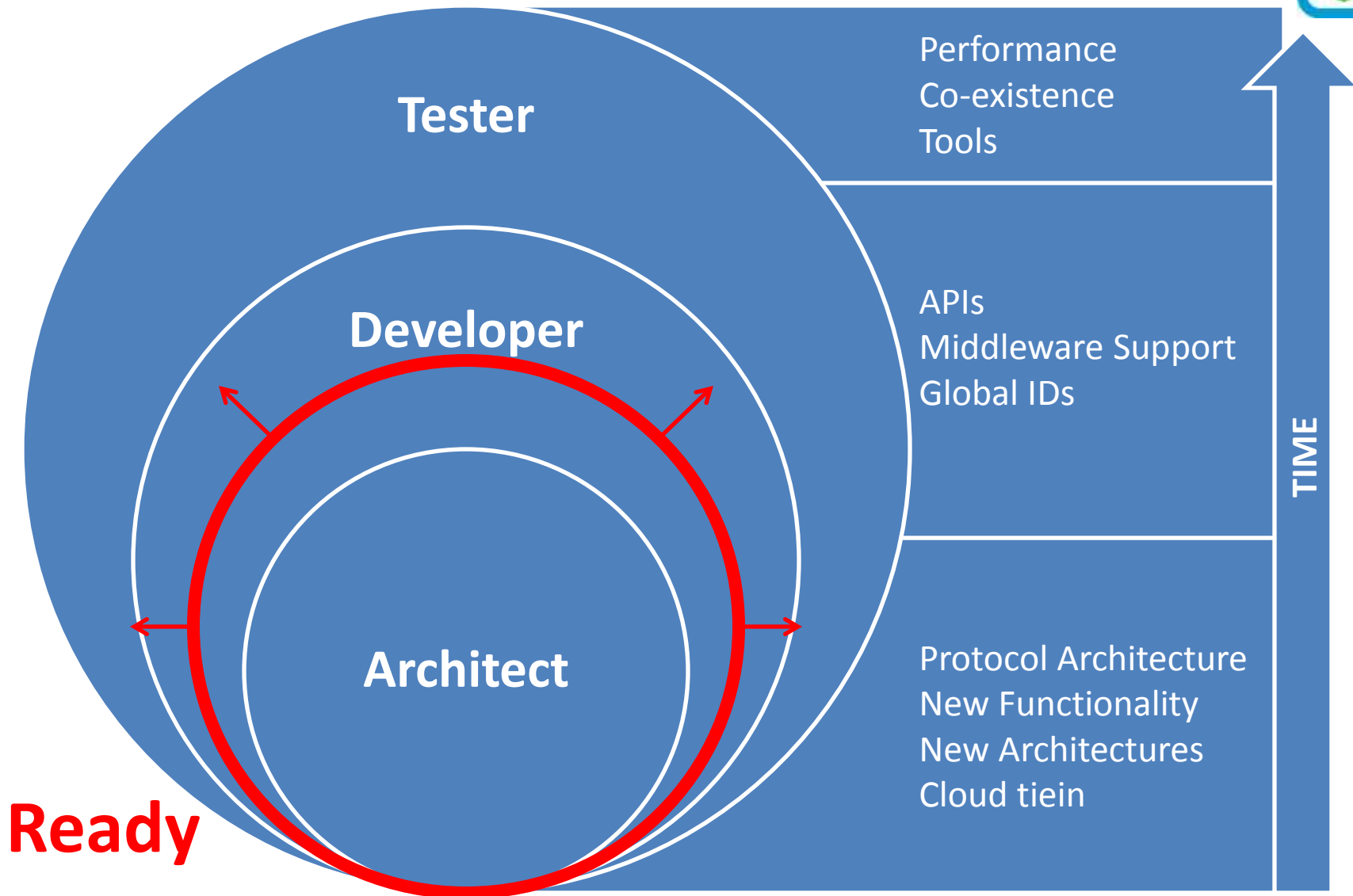

Knowledge for the Trial – What to Train On

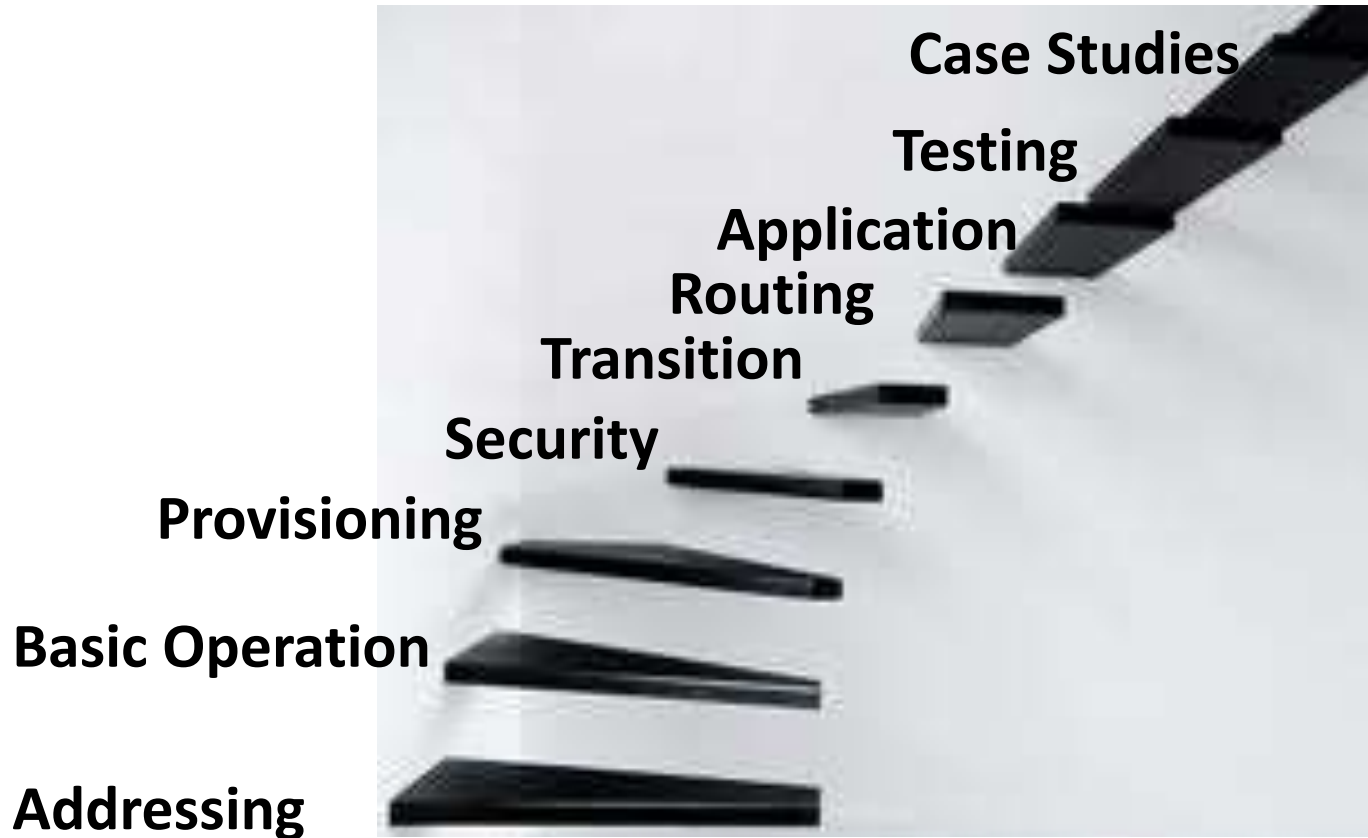



- IPv6 is similar to IPv4 – I will map IPv4
- IPv6 is actually different than IPv4 – I will do things differently than in IPv4
- IPv6 is a better enabler of next generation IT infrastructures – I will build my Next Gen IT

Hands-on – How to train



Test Environments:

- New, dedicated
- Existing, ready

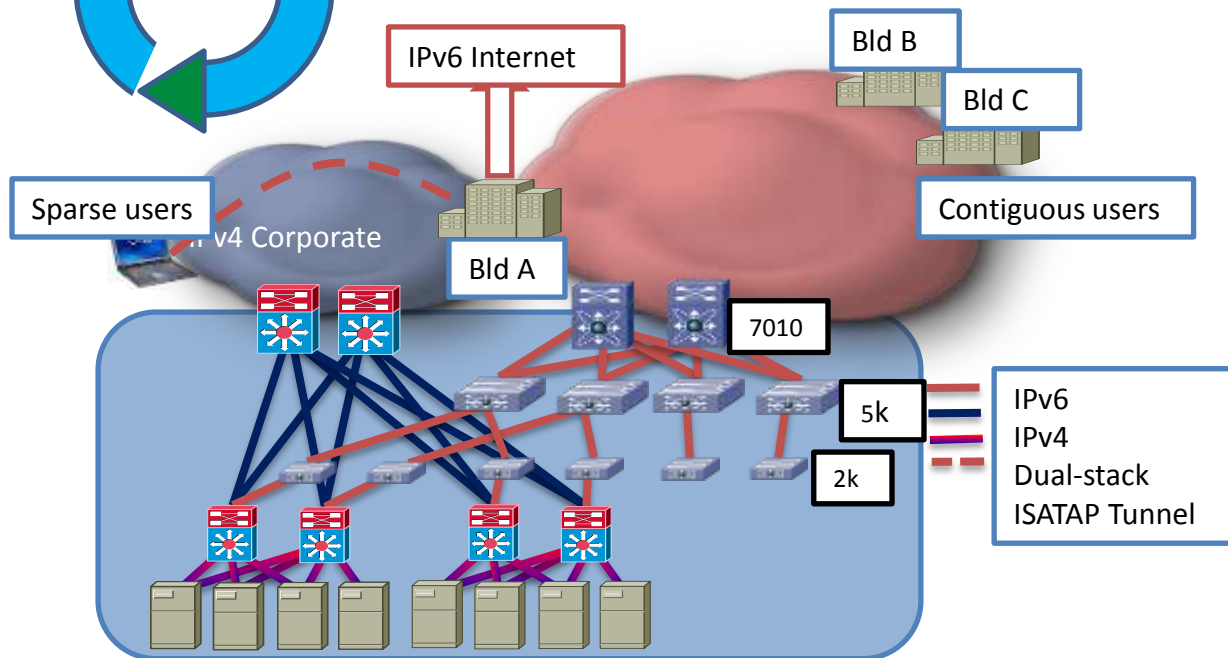
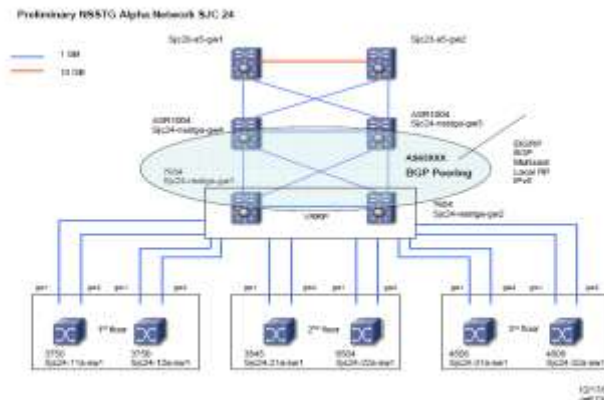
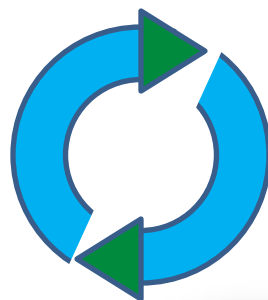
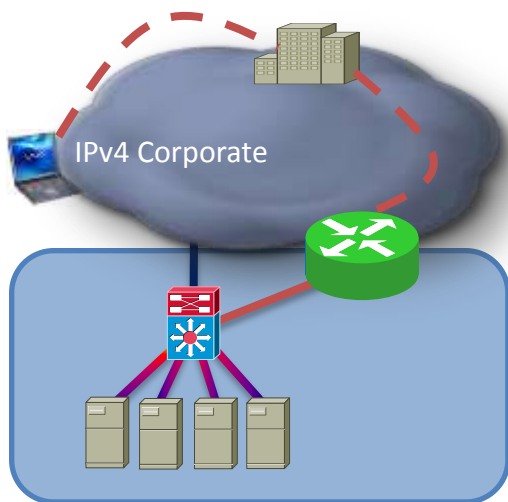



right Training for the right People at the right Time

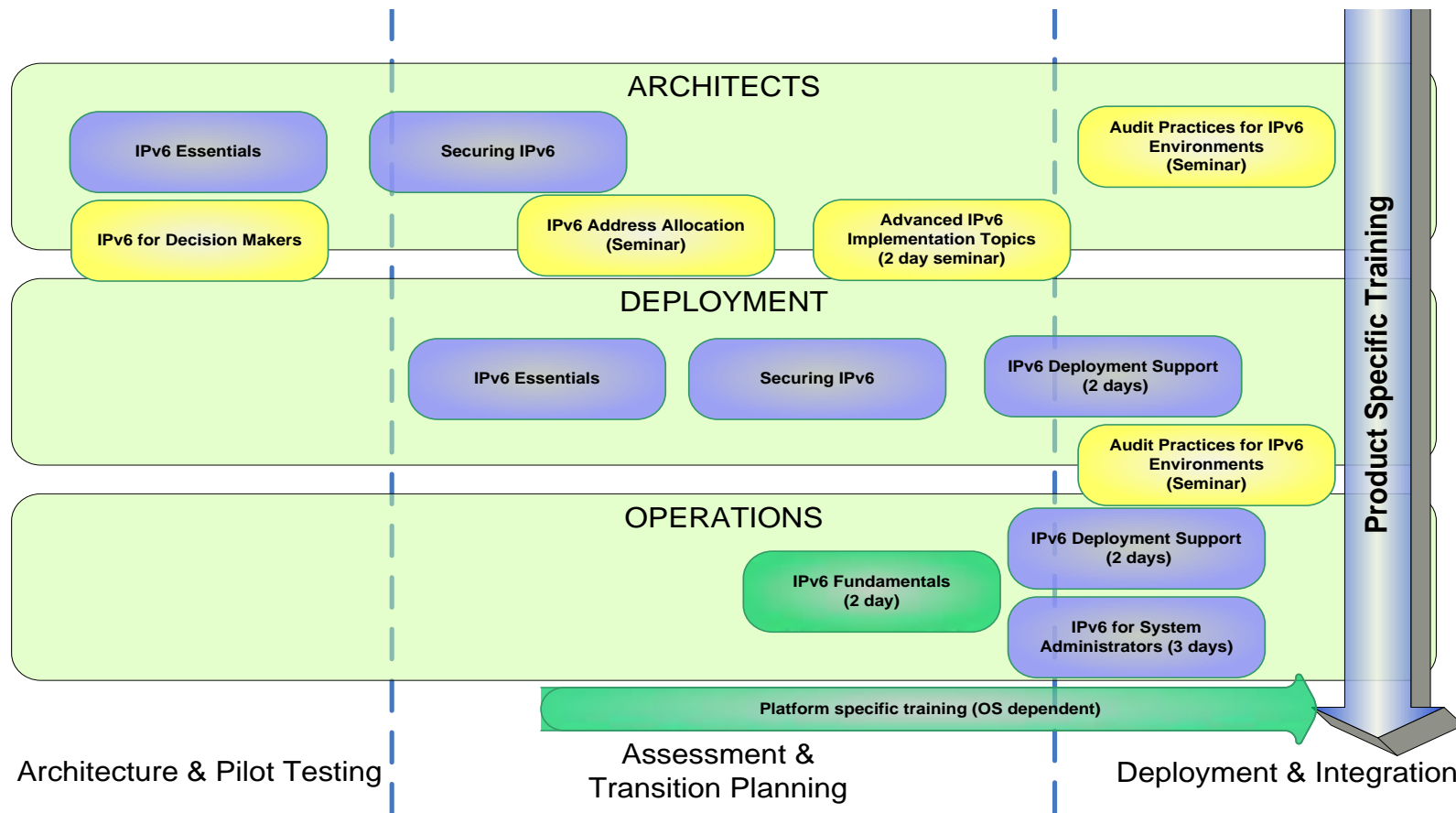



- **Expert** developed coursework and labs
- **Relevant** content up to date with the latest developments
- **Insightful** perspective that goes beyond stock information
- **Theory+Hands On** for effective learning
- **Experienced** trainers, practitioner SMEs
- **Proven** value

Maximize ROI – When to Start



- Start as soon as possible, preferably yesterday
- Start with the architects and decision makers
- Have the whole plan lined up from the start



- IPv6 is not your father's IP – get it right
- IPv6 touches everything IT – get it to everyone
- IPv6 transition take time – get it at the right time
- Not all IPv6 training is created equal – get it the right way

Let's get serious about this!

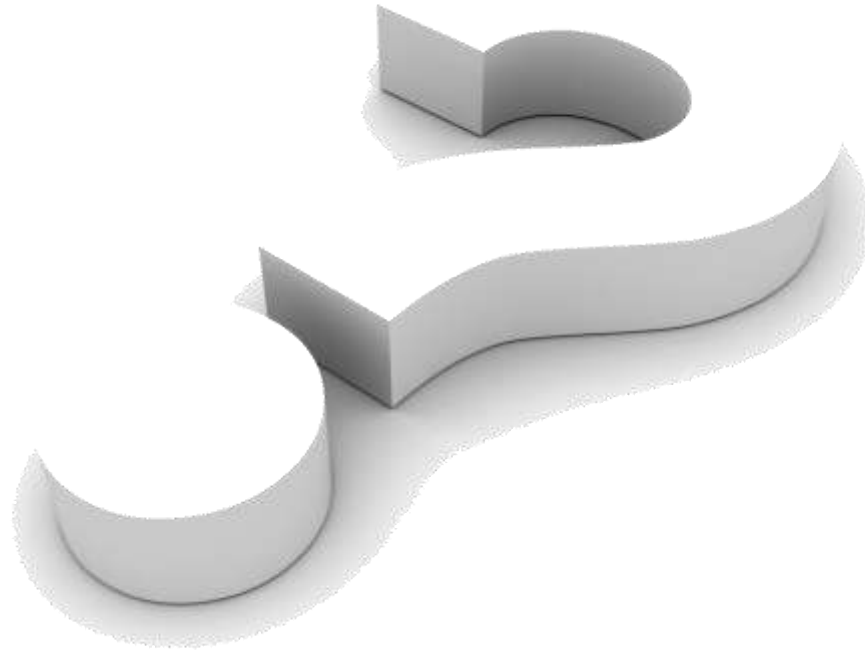



Business Transformation One Step at a Time

e: contact@nephos6.com

p: (919)647-4773

w: www.nephos6.com